

NMR Spectroscopy: Principles and Applications

Nagarajan Murali

**Coherence Selection & How A
Spectrometer Works**

Lecture 8

Coherence Selection

We have seen several homonuclear and heteronuclear 1D and 2D experiments. It is instructive to understand how these various experiments select the information by retaining the desired coherence transfers and suppressing the undesired transfers. For example in DQFC we said we will retain only the DQ coherences between the second and third pulse.

Coherence Selection in DQFC

After the second 90° pulse we retain only the DQC.

$$\begin{aligned}
 & -\cos(\Omega_1 t_1) \sin(\pi J_{12} t_1) 2I_{1x} I_{2y} \quad \boxed{\text{DQ}} \quad \boxed{\text{ZQ}} \\
 & = -\cos(\Omega_1 t_1) \sin(\pi J_{12} t_1) \frac{1}{2} \left[(2I_{1x} I_{2y} + 2I_{1y} I_{2x}) + (2I_{1x} I_{2y} - 2I_{1y} I_{2x}) \right]
 \end{aligned}$$

$\downarrow \frac{\pi}{2} I_x$ Third 90° pulse

$$-\cos(\Omega_1 t_1) \sin(\pi J_{12} t_1) \frac{1}{2} \left[(2I_{1x} I_{2z} + 2I_{1z} I_{2x}) \right]$$



Coherence Selection

The spins in the sample evolve according to the interactions active during the pulse sequence and transform depending on the axis along which the RF pulses are applied. There are two ways of achieving the coherence selection – (1) by phase cycling the RF pulses and the receiver and (2) by applying pulsed field gradients.

Coherence Selection – Phase Cycling

Let us first focus on the phase cycling approach. Applying a $\pi/2$ pulse along x-axis rotates z-magnetization to $-y$ axis which when observed along $+y$ axis can be represented by a negative absorption lineshape.

Applying $\pi/2$ pulse along x-axis and observing along x-axis will give a negative dispersion line shape.

Applying $\pi/2$ pulse along y-axis and observing along x-axis will give a positive absorption line shape.

The pulse axis and receiver axis decides the shape of the spectrum.

Coherence Selection – Phase Cycling

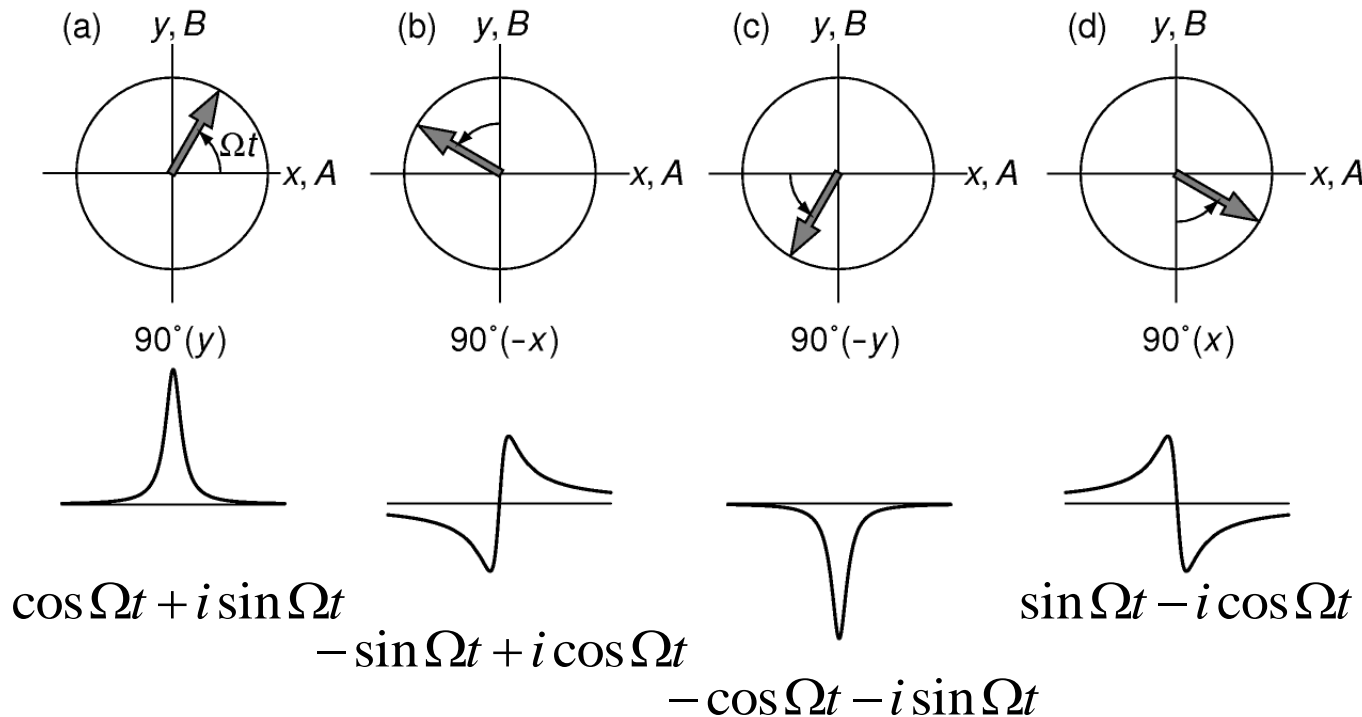

Here, the signal $S(t)$ is detected along x -axis and the y -axis with definition that x -axis signal is real part (A) and the y -axis signal is imaginary part (B). Thus as the pulse phase is changed the signal shape changes as the receiver definition (phase) remains the same.

Coherence Selection – Phase Cycling

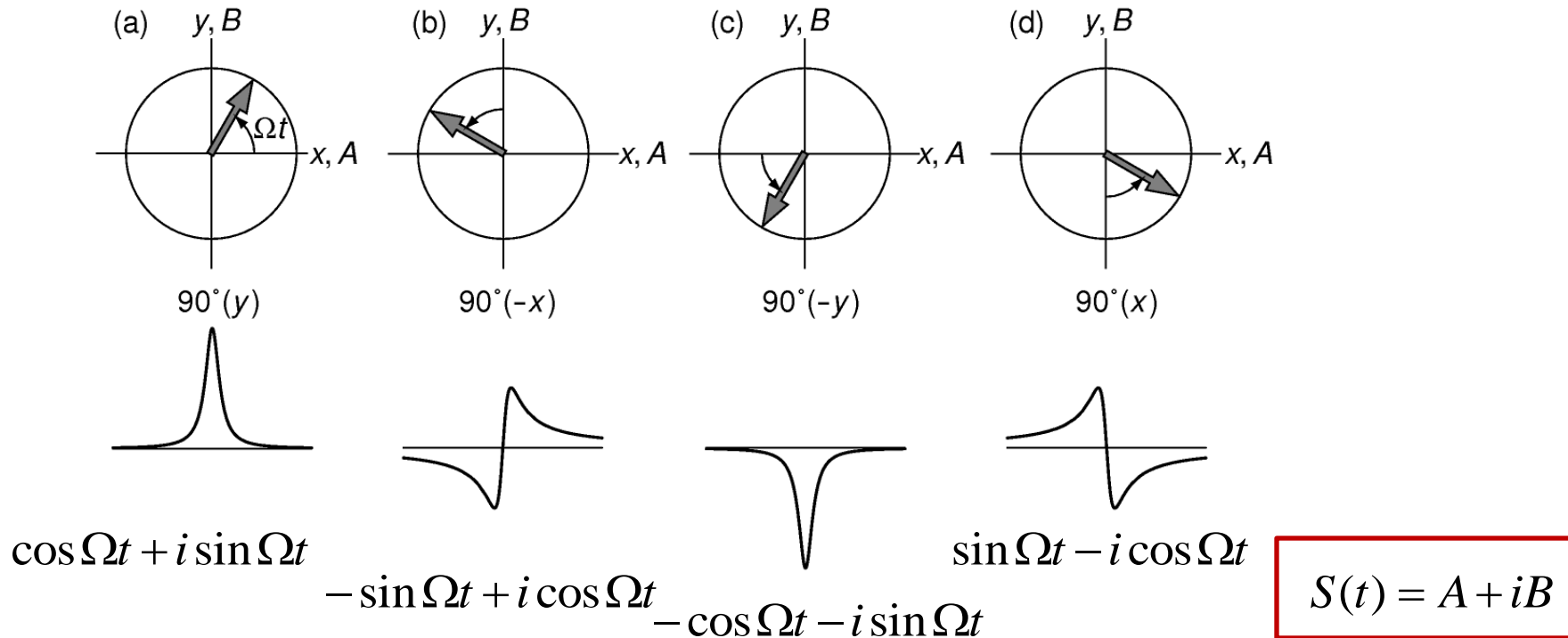

Instead of combining $S(t)=A+iB$ for all the cases, we can combine the two signals in (a) $A+iB$, (b) $B-iA$, (c) $-A-iB$, and (d) $-B+iA$. Then all detected signal will be same yielding same shape. The various types of addition is achieved by changing the receiver phase.

Coherence Selection – Phase Cycling

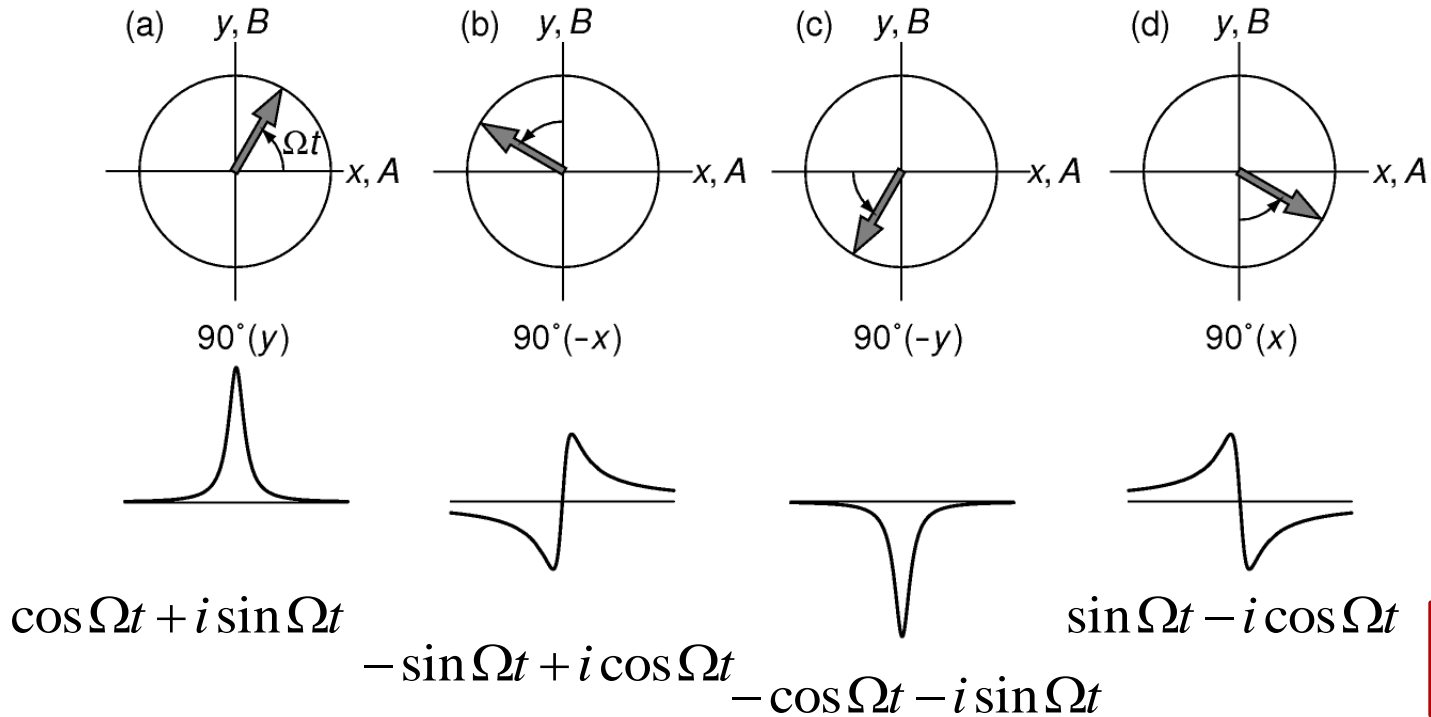

$$S(t) = A + iB$$

Consider the case (b): $S_b(t) = A + iB = -\sin \Omega t + i \cos \Omega t$

$$-i \times S_b(t) = -iA + B = i \sin \Omega t + \cos \Omega t$$

Same as case (a)

Multiplying by $-i$ is same as adding a phase $-\pi/2$ to the signal.

$$e^{-i\frac{\pi}{2}} = \cos \frac{\pi}{2} - i \sin \frac{\pi}{2} = -i$$

Coherence Selection – Phase Cycling

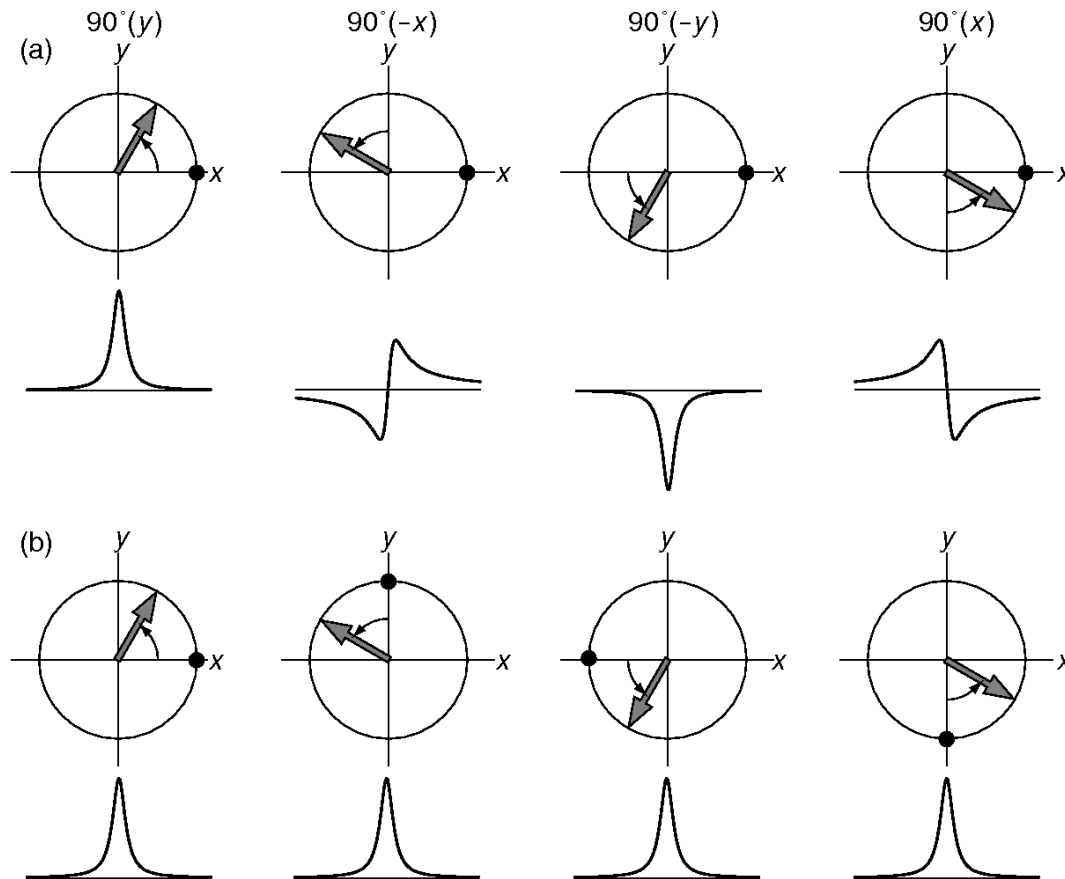

The Pulse phase is represented with the flip angle and the receiver phase is marked by the dot. In (a) the receiver phase is held constant and addition of 4 spectra will give null signal. In (b) the receiver is -90° out of phase with respect to the pulse phase and the addition of resulting 4 spectra add up to give a signal averaged absorption spectrum.

DQFC Experiment: Phase Cycling

Let us consider the DQFC Experiment: Phase step 1

$$I_{1z} \xrightarrow{\frac{\pi}{2} I_x} -I_{1y} \xrightarrow{\Omega_1 t_1 I_{1z}} -I_{1y} \cos(\Omega_1 t_1) + I_{1x} \sin(\Omega_1 t_1) \xrightarrow{2\pi J_{12} t_1 I_{1z} I_{2z}}$$

$$- \cos(\Omega_1 t_1) \cos(\pi J_{12} t_1) I_{1y} + \cos(\Omega_1 t_1) \sin(\pi J_{12} t_1) 2I_{1x} I_{2z}$$

$$+ \sin(\Omega_1 t_1) \cos(\pi J_{12} t_1) I_{1x} + \sin(\Omega_1 t_1) \sin(\pi J_{12} t_1) 2I_{1y} I_{2z}$$

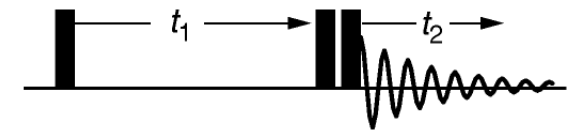

$$\xrightarrow{\frac{\pi}{2} I_x}$$

$$- \cos(\Omega_1 t_1) \cos(\pi J_{12} t_1) I_{1z} - \cos(\Omega_1 t_1) \sin(\pi J_{12} t_1) 2I_{1x} I_{2y}$$

$$+ \sin(\Omega_1 t_1) \cos(\pi J_{12} t_1) I_{1x} - \sin(\Omega_1 t_1) \sin(\pi J_{12} t_1) 2I_{1z} I_{2y}$$

$$\xrightarrow{\frac{\pi}{2} I_x}$$

$$\cos(\Omega_1 t_1) \cos(\pi J_{12} t_1) I_{1y} - \cos(\Omega_1 t_1) \sin(\pi J_{12} t_1) 2I_{1x} I_{2z}$$

$$+ \sin(\Omega_1 t_1) \cos(\pi J_{12} t_1) I_{1x} + \sin(\Omega_1 t_1) \sin(\pi J_{12} t_1) 2I_{1y} I_{2z}$$

DQFC Experiment: Phase Cycling

DQFC Experiment: Phase step 2

$$I_{1z} \xrightarrow{\frac{\pi}{2} I_y} I_{1x} \xrightarrow{\Omega_1 t_1 I_{1z}} I_{1x} \cos(\Omega_1 t_1) + I_{1y} \sin(\Omega_1 t_1) \xrightarrow{2\pi J_{12} t_1 I_{1z} I_{2z}}$$

$$\cos(\Omega_1 t_1) \cos(\pi J_{12} t_1) I_{1x} + \cos(\Omega_1 t_1) \sin(\pi J_{12} t_1) 2I_{1y} I_{2z}$$

$$+ \sin(\Omega_1 t_1) \cos(\pi J_{12} t_1) I_{1y} - \sin(\Omega_1 t_1) \sin(\pi J_{12} t_1) 2I_{1x} I_{2z}$$

$$\xrightarrow{\frac{\pi}{2} I_y}$$

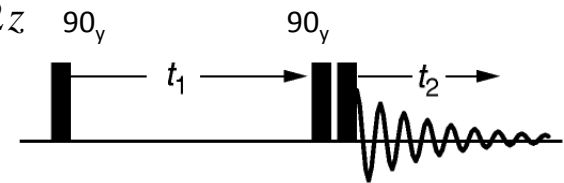

$$- \cos(\Omega_1 t_1) \cos(\pi J_{12} t_1) I_{1z} + \cos(\Omega_1 t_1) \sin(\pi J_{12} t_1) 2I_{1y} I_{2x}$$

$$+ \sin(\Omega_1 t_1) \cos(\pi J_{12} t_1) I_{1y} + \sin(\Omega_1 t_1) \sin(\pi J_{12} t_1) 2I_{1z} I_{2x}$$

$$\xrightarrow{\frac{\pi}{2} I_x}$$

$$\cos(\Omega_1 t_1) \cos(\pi J_{12} t_1) I_{1y} + \cos(\Omega_1 t_1) \sin(\pi J_{12} t_1) 2I_{1z} I_{2x}$$

$$+ \sin(\Omega_1 t_1) \cos(\pi J_{12} t_1) I_{1z} - \sin(\Omega_1 t_1) \sin(\pi J_{12} t_1) 2I_{1y} I_{2z}$$

DQFC Experiment: Phase Cycling

DQFC Experiment: Phase step 3

$$\begin{aligned}
 I_{1z} &\xrightarrow{-\left(\frac{\pi}{2}I_x\right)} I_{1y} \xrightarrow{\Omega_1 t_1 I_{1z}} I_{1y} \cos(\Omega_1 t_1) - I_{1x} \sin(\Omega_1 t_1) \xrightarrow{2\pi J_{12} t_1 I_{1z} I_{2z}} \\
 &\cos(\Omega_1 t_1) \cos(\pi J_{12} t_1) I_{1y} - \cos(\Omega_1 t_1) \sin(\pi J_{12} t_1) 2I_{1x} I_{2z} \\
 &- \sin(\Omega_1 t_1) \cos(\pi J_{12} t_1) I_{1x} - \sin(\Omega_1 t_1) \sin(\pi J_{12} t_1) 2I_{1y} I_{2z} \\
 &\xrightarrow{-\left(\frac{\pi}{2}I_x\right)}
 \end{aligned}$$

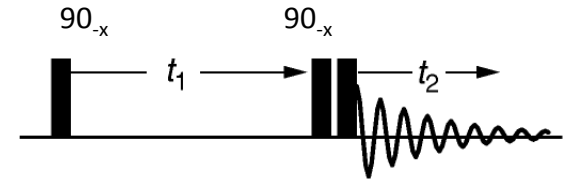

$$\begin{aligned}
 &- \cos(\Omega_1 t_1) \cos(\pi J_{12} t_1) I_{1z} - \cos(\Omega_1 t_1) \sin(\pi J_{12} t_1) 2I_{1x} I_{2y} \\
 &- \sin(\Omega_1 t_1) \cos(\pi J_{12} t_1) I_{1x} + \sin(\Omega_1 t_1) \sin(\pi J_{12} t_1) 2I_{1z} I_{2y}
 \end{aligned}$$

$$\begin{aligned}
 &\xrightarrow{\frac{\pi}{2}I_x} \\
 &\cos(\Omega_1 t_1) \cos(\pi J_{12} t_1) I_{1y} - \cos(\Omega_1 t_1) \sin(\pi J_{12} t_1) 2I_{1x} I_{2z} \\
 &- \sin(\Omega_1 t_1) \cos(\pi J_{12} t_1) I_{1x} - \sin(\Omega_1 t_1) \sin(\pi J_{12} t_1) 2I_{1y} I_{2z}
 \end{aligned}$$

DQFC Experiment: Phase Cycling

DQFC Experiment: Phase step 4

$$\begin{aligned}
 I_{1z} &\xrightarrow{-\left(\frac{\pi}{2}I_y\right)} -I_{1x} \xrightarrow{\Omega_1 t_1 I_{1z}} -I_{1x} \cos(\Omega_1 t_1) - I_{1y} \sin(\Omega_1 t_1) \xrightarrow{2\pi J_{12} t_1 I_{1z} I_{2z}} \\
 &-\cos(\Omega_1 t_1) \cos(\pi J_{12} t_1) I_{1x} - \cos(\Omega_1 t_1) \sin(\pi J_{12} t_1) 2I_{1y} I_{2z} \\
 &-\sin(\Omega_1 t_1) \cos(\pi J_{12} t_1) I_{1y} + \sin(\Omega_1 t_1) \sin(\pi J_{12} t_1) 2I_{1x} I_{2z} \\
 &\xrightarrow{-\left(\frac{\pi}{2}I_y\right)}
 \end{aligned}$$

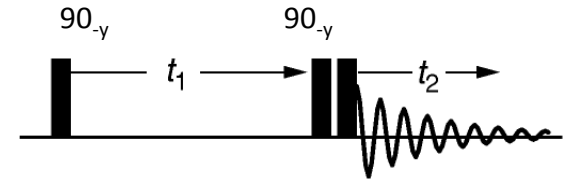

$$\begin{aligned}
 &-\cos(\Omega_1 t_1) \cos(\pi J_{12} t_1) I_{1z} - \cos(\Omega_1 t_1) \sin(\pi J_{12} t_1) 2I_{1y} I_{2x} \\
 &-\sin(\Omega_1 t_1) \cos(\pi J_{12} t_1) I_{1y} - \sin(\Omega_1 t_1) \sin(\pi J_{12} t_1) 2I_{1z} I_{2x}
 \end{aligned}$$

$$\xrightarrow{\frac{\pi}{2}I_x}$$

$$\begin{aligned}
 &\cos(\Omega_1 t_1) \cos(\pi J_{12} t_1) I_{1y} - \cos(\Omega_1 t_1) \sin(\pi J_{12} t_1) 2I_{1z} I_{2x} \\
 &-\sin(\Omega_1 t_1) \cos(\pi J_{12} t_1) I_{1z} + \sin(\Omega_1 t_1) \sin(\pi J_{12} t_1) 2I_{1y} I_{2z}
 \end{aligned}$$

DQFC Experiment: Phase Cycling

DQFC Experiment: $\{(1)-(2)+(3)-(4)\} = -2(2I_{1x}I_{2y} + 2I_{1y}I_{2x})$

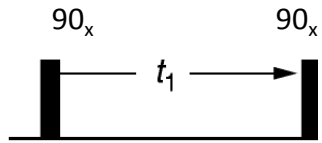

$$\begin{aligned}
 & -\cos(\Omega_1 t_1) \cos(\pi J_{12} t_1) I_{1z} - \cos(\Omega_1 t_1) \sin(\pi J_{12} t_1) 2I_{1x} I_{2y} \\
 & + \sin(\Omega_1 t_1) \cos(\pi J_{12} t_1) I_{1x} - \sin(\Omega_1 t_1) \sin(\pi J_{12} t_1) 2I_{1z} I_{2y}
 \end{aligned}$$

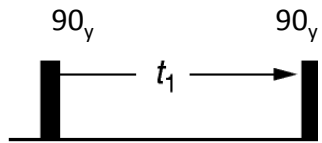

$$\begin{aligned}
 & -\cos(\Omega_1 t_1) \cos(\pi J_{12} t_1) I_{1z} + \cos(\Omega_1 t_1) \sin(\pi J_{12} t_1) 2I_{1y} I_{2x} \\
 & + \sin(\Omega_1 t_1) \cos(\pi J_{12} t_1) I_{1y} + \sin(\Omega_1 t_1) \sin(\pi J_{12} t_1) 2I_{1z} I_{2x}
 \end{aligned}$$

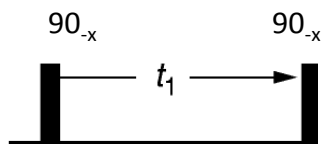

$$\begin{aligned}
 & -\cos(\Omega_1 t_1) \cos(\pi J_{12} t_1) I_{1z} - \cos(\Omega_1 t_1) \sin(\pi J_{12} t_1) 2I_{1x} I_{2y} \\
 & - \sin(\Omega_1 t_1) \cos(\pi J_{12} t_1) I_{1x} + \sin(\Omega_1 t_1) \sin(\pi J_{12} t_1) 2I_{1z} I_{2y}
 \end{aligned}$$

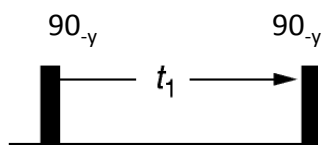

$$\begin{aligned}
 & -\cos(\Omega_1 t_1) \cos(\pi J_{12} t_1) I_{1z} - \cos(\Omega_1 t_1) \sin(\pi J_{12} t_1) 2I_{1y} I_{2x} \\
 & - \sin(\Omega_1 t_1) \cos(\pi J_{12} t_1) I_{1y} - \sin(\Omega_1 t_1) \sin(\pi J_{12} t_1) 2I_{1z} I_{2x}
 \end{aligned}$$

Coherence Transfer Pathway

*DQFC Experiment: $\{(1)-(2)+(3)-(4)\} = -2(2I_{1x}I_{2y} + 2I_{1y}I_{2x})$ The receiver phase is set to $+x$, $+y$, $-x$, and $-y$ to achieve the add/subtraction. Since the signal arise from four scans, we divide the total by 4 to yield $\{(1)-(2)+(3)-(4)\}/4 = -2(2I_{1x}I_{2y} + 2I_{1y}I_{2x})/4 = -1/2(2I_{1x}I_{2y} + 2I_{1y}I_{2x})$ is the desired signal. The entire sequence of events can be represented by a diagram called **coherence transfer pathway diagram**.*

In the figure below we see that the first pulse creates SQCs that evolve during t_1 and after the second pulse we retain DQCs and then the last pulse converts the DQCs to observables.

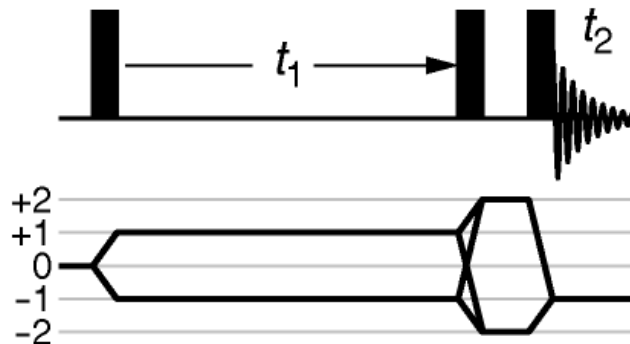

Rotation About Z

Pulses are applied along an axis perpendicular to the z-axis. If we set the phase ϕ of a pulse is zero when it is applied along x-axis, then when a 90° rotation of the pulse about z-axis yields a pulse along y-axis.

$$\begin{array}{ccc}
 \alpha I_x \xrightarrow{\frac{\pi}{2} I_z} \alpha I_y & & I_z \xrightarrow{\frac{\pi}{2} I_x} -I_y \\
 \alpha_x \downarrow \xrightarrow{\frac{\pi}{2} I_z} \downarrow \alpha_y & & I_z \xrightarrow{\frac{\pi}{2} I_y} I_x \\
 & & I_z \xrightarrow{\frac{\pi}{2} I_x} -I_y \xrightarrow{\frac{\pi}{2} I_z} I_x
 \end{array}$$

Thus, phase cycling is equivalent to a rotation about z-axis.

Raising and Lowering Operators

We have seen earlier properties of Spin operators:

$$\hat{I}_z \left| \frac{1}{2} \right\rangle = \frac{1}{2} \left| \frac{1}{2} \right\rangle \quad \hat{I}_z \left| -\frac{1}{2} \right\rangle = -\frac{1}{2} \left| -\frac{1}{2} \right\rangle$$

$$\hat{I}_x \left| \frac{1}{2} \right\rangle = \frac{1}{2} \left| -\frac{1}{2} \right\rangle \quad \hat{I}_x \left| -\frac{1}{2} \right\rangle = \frac{1}{2} \left| \frac{1}{2} \right\rangle$$

$$\hat{I}_y \left| \frac{1}{2} \right\rangle = \frac{i}{2} \left| \frac{1}{2} \right\rangle \quad \hat{I}_y \left| -\frac{1}{2} \right\rangle = -\frac{i}{2} \left| \frac{1}{2} \right\rangle$$

$$\hat{I}_+ \left| \frac{1}{2} \right\rangle = 0$$

$$\hat{I}_- \left| -\frac{1}{2} \right\rangle = 0$$

$$\left(\hat{I}_x + i\hat{I}_y \right) \left| -\frac{1}{2} \right\rangle = \hat{I}_x \left| -\frac{1}{2} \right\rangle + i\hat{I}_y \left| -\frac{1}{2} \right\rangle = \frac{1}{2} \left| \frac{1}{2} \right\rangle + \frac{1}{2} \left| \frac{1}{2} \right\rangle$$

$$\hat{I}_+ \left| -\frac{1}{2} \right\rangle = \left| \frac{1}{2} \right\rangle$$

This is called a raising operator, the change in quantum number is +1. The coherence $p=1$ is created.

$$\left(\hat{I}_x - i\hat{I}_y \right) \left| \frac{1}{2} \right\rangle = \hat{I}_x \left| \frac{1}{2} \right\rangle - i\hat{I}_y \left| \frac{1}{2} \right\rangle = \frac{1}{2} \left| -\frac{1}{2} \right\rangle + \frac{1}{2} \left| -\frac{1}{2} \right\rangle$$

$$\hat{I}_- \left| \frac{1}{2} \right\rangle = \left| -\frac{1}{2} \right\rangle$$

This is called a lowering operator, the change in quantum number is -1. The coherence $p=-1$ is created.

Rotation About z

Let us rotate the raising and lowering operator undergo rotation about z:

$$\begin{aligned} I_+ &\xrightarrow{\phi I_z} (I_x + iI_y) \xrightarrow{\phi I_z} \cos \phi I_x + \sin \phi I_y + i(\cos \phi I_y + \sin \phi I_x) \\ &= \cos \phi (I_x + iI_y) - i \sin \phi (I_x + iI_y) \\ &= (\cos \phi - i \sin \phi) (I_x + iI_y) \\ &= \exp(-i\phi) I_+ \end{aligned}$$

$$\begin{aligned} I_- &\xrightarrow{\phi I_z} (I_x - iI_y) \xrightarrow{\phi I_z} \cos \phi I_x + \sin \phi I_y - i(\cos \phi I_y + \sin \phi I_x) \\ &= \cos \phi (I_x - iI_y) + i \sin \phi (I_x - iI_y) \\ &= (\cos \phi + i \sin \phi) (I_x - iI_y) \\ &= \exp(i\phi) I_- \end{aligned}$$

When the phase step is set to an angle ϕ , the raising operator, +1 single quantum coherence, accumulates a phase $-\phi$. The lowering operator (-1 SQC) accumulates a phase $+\phi$. For the coherence order p the phase change is $-p\phi$.

Rotation About z

Let us focus on the DQ coherence given by the operator $(2I_{1x}I_{2y} + 2I_{1y}I_{2x})$ undergo rotation about z:

$$\begin{aligned}
 2I_{1x}I_{2y} + 2I_{1y}I_{2x} &= 2 \frac{(I_{1+} + I_{1-})}{2} \frac{(I_{2+} - I_{2-})}{2i} + 2 \frac{(I_{1+} - I_{1-})}{2i} \frac{(I_{2+} + I_{2-})}{2} \\
 &= \frac{I_{1+}I_{2+} - I_{1+}I_{2-} + I_{1-}I_{2+} - I_{1-}I_{2-} + I_{1+}I_{2+} + I_{1+}I_{2-} - I_{1-}I_{2+} - I_{1-}I_{2-}}{2i} \\
 &= \frac{1}{i} (I_{1+}I_{2+} - I_{1-}I_{2-}) \\
 &\quad \begin{matrix} p=+2 & p=-2 \end{matrix}
 \end{aligned}$$

$$I_{1+}I_{2+} \xrightarrow{\phi I_z} I_{1+}e^{-i\phi} I_{2+}e^{-i\phi} = I_{1+}I_{2+}e^{-i2\phi}$$

$$I_{1-}I_{2-} \xrightarrow{\phi I_z} I_{1-}e^{i\phi} I_{2-}e^{i\phi} = I_{1-}I_{2-}e^{i2\phi}$$

For the coherence order p the phase change is $-p\phi$.

DQFC Experiment: Phase Cycling

DQFC Experiment: $\{(1)-(2)+(3)-(4)\} = -2(2I_{1x}I_{2y} + 2I_{1y}I_{2x})$

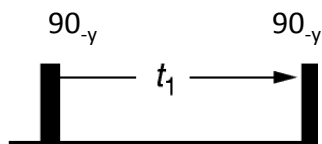
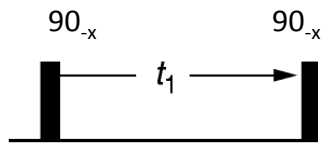
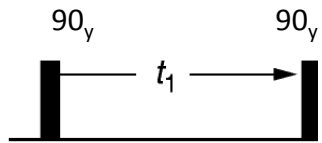
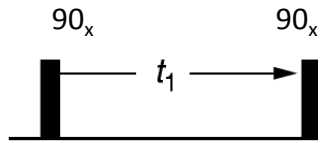

SQC	DQC	Z or ZQC	Receiver
0	0	0	0
90	180	0	180
180	360=0	0	0
270	540 = 180	0	180

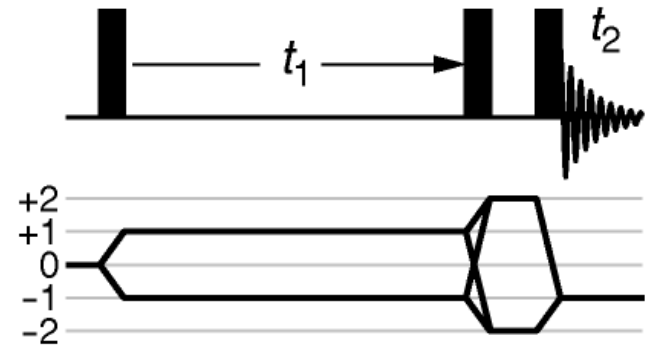

The first 90° pulse excited the $p=\pm 1$ coherences and the second 90° pulse transferred it to all other coherences, but the phase cycling of the first two 90° pulses and the receiver retained only the transfer pathway from $p=\pm 2$ coherences to $p=-1$ coherence for detection by the third 90° pulse.

Coherence Transfer Pathway and Phase Cycling

When a pulse transfers a coherence of order p_1 to p_2 the change in coherence order is $\Delta p = (p_2 - p_1)$ and if the pulse phase is shifted by $\Delta\phi$, then the phase change accumulated in this transfer is $-(\Delta p * \Delta\phi)$.

Step	$\Delta\phi$	$3\Delta\phi$	Reduced $3\Delta\phi$	Receiver phase
1	0°	0°	0°	0°
2	90°	270°	270°	270°
3	180°	540°	180°	180°
4	270°	810°	90°	90°

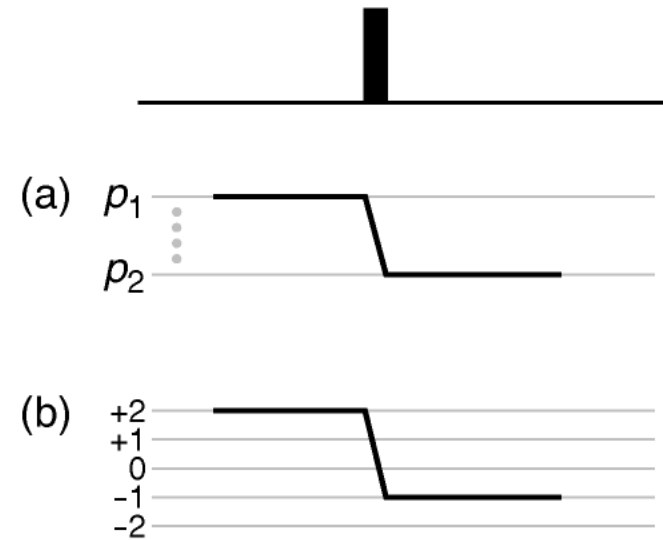

In (a) $\Delta p = (p_2 - p_1)$, in (b) $\Delta p = (-1 - 2) = -3$. Consider the case (b). If we step the phase of the pulse as $0^\circ, 90^\circ, 180^\circ, 270^\circ$ (x, y, -x, -y), then the accumulated phase shift for this particular change in pathway is given by $-(\Delta p * \Delta\phi) = -(-3 * \Delta\phi) = 3\Delta\phi$.

If we want this pathway $\Delta p = -3$ to be selected then we set the receiver phase to match the accumulated phase by this pathway.

Coherence Transfer Pathway and Phase Cycling

*How can we be sure that other pathways are rejected? Let us consider a pathway that has $\Delta p = -2$, then the accumulated phase for this pathway will be $-(\Delta p * \Delta \phi) = 2\Delta \phi$.*

Step	$\Delta \phi$	$3\Delta \phi$	Reduced $3\Delta \phi$	$2\Delta \phi$	Reduced $2\Delta \phi$	Receiver phase
1	0°	0°	0°	0°	0°	0°
2	90°	270°	270°	180°	180°	270°
3	180°	540°	180°	360°	0°	180°
4	270°	810°	90°	540°	180°	90°

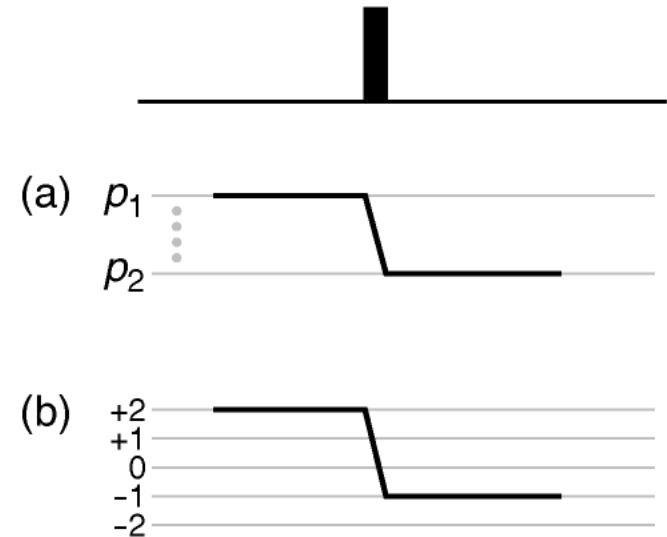

Cells in column 3 adds up with the receiver as we want, but the cells in column 6 cancel each other as the receiver phase is changed (column 6 - cell 1 cancels cell 3, and cell 2 cancels cell 4). If we continue this type of analysis, we will find that a 4 step phase cycle that selects $\Delta p = -3$ pathway while rejecting many other pathways (shown in ()) allow some other pathways (bold letter) too.

*(-5)(-4) **-3** (-2) (-1) (0) **1** (2) (3) (4) **5***

DQFC Experiment: Phase Cycling

We can arrive at a different type of phase cycling scheme for DQFC with the coherence transfer pathway analysis. Suppose if we keep the phases of the first and second pulses constant and phase cycle the third pulse – we have to select $\Delta p = (-1 - 2) = -3$ and $\Delta p = (-1 - (-2)) = 1$. We can do 4 step phase cycle which would select both.

(-4) -3 (-2) (-1) (0) 1 (2) (3)

ϕ_3	$3\phi_3$	Receiver
0°	0°	0°
90°	270°	270°
180°	$540^\circ = 180^\circ$	180°
270°	$810^\circ = 90^\circ$	90°

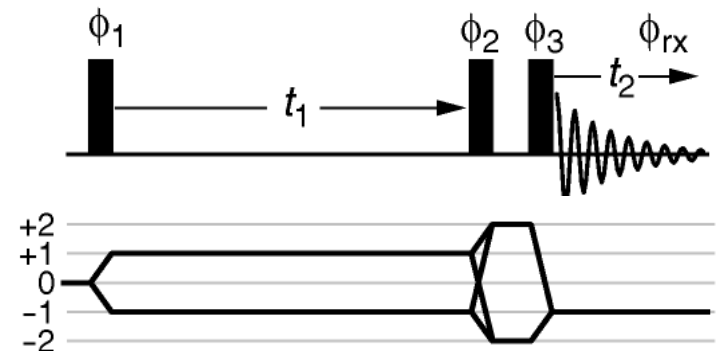

DQFC Experiment: Phase Cycling

The phase cycle of ϕ_1 and ϕ_2 together keeping ϕ_3 constant yielded the previous phase cycle scheme.

ϕ_1 and ϕ_2	DQC	Receiver
0	0	0
90	180	180
180	360=0	0
270	540 =180	180

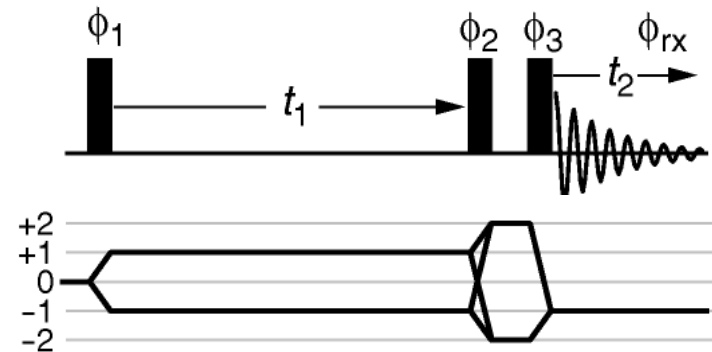

If we have to cycle individual pulses to select a particular coherence transfer pathway scheme then the total number of steps will become $n_1 \times n_2 \times n_3 \dots$ where n_i is the number of steps to be cycled for the i -th pulse and the receiver also takes that many steps with proper incremented phase.

Pulsed Field Gradients

Normally we maintain the homogeneity of the applied B_0 field throughout the experiment. But, there are times when we can apply a known amount of field gradient along z-axis for a short duration of time and then restore the homogeneity back. We said to have applied a pulsed field gradient.

(a) Usual NMR sample in a homogeneous B_0 field giving rise to a sharp peak. (b) The gradient field varies linearly along z-axis negative below the center of the active volume (grey rectangle) and positive above the center. The Larmor frequency varies as a function of z since the field is varying and a broad line is observed.

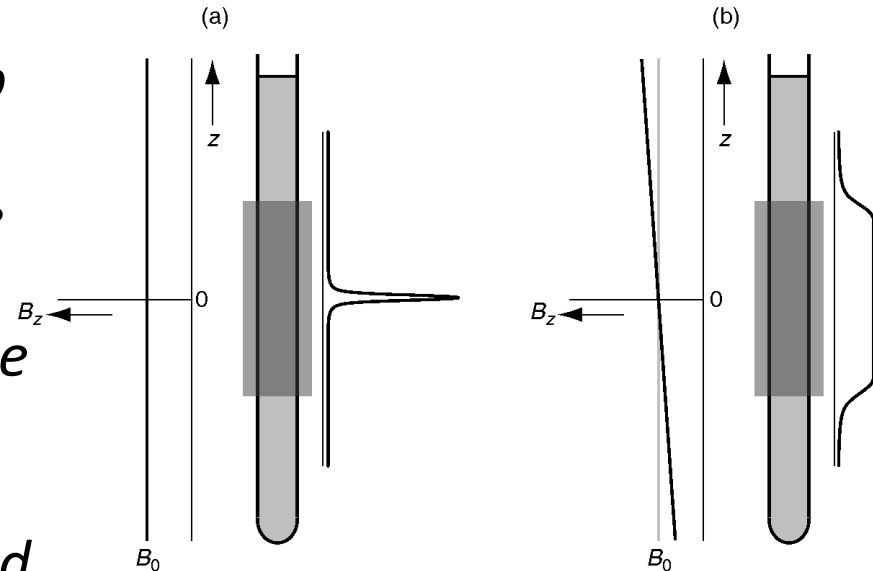

Pulsed Field Gradients

The net field along z during a pulsed field gradient (PFG) pulse is:

$$B_z = B_0 + Gz$$

Where G is the magnetic field gradient in units of Tesla per meter ($T m^{-1}$). Usually G will be expressed in Gauss per cm

$$G (cm)^{-1} = (T m^{-1}) 10^{-4} * 10^2 = (T m^{-1}) 10^{-2}$$

The Larmor frequency is given by:

$$-\gamma B_z = -\gamma B_0 - \gamma Gz$$

$$\omega_z = \omega_0 - \gamma Gz = \omega_0 + \Omega(z)$$

The first part is same for all spins irrespective of position, where as the second part is the de-phasing based on the PFG at any position z.

Pulsed Field Gradients

The net field along z during a pulsed field gradient (PFG) pulse is:

$$B_z = B_0 + Gz$$

$$-\gamma B_z = -\gamma B_0 - \gamma Gz; \quad \omega_z = \omega_0 - \gamma Gz = \omega_0 + \Omega(z)$$

The first part is same for all spins irrespective of position, where as the second part is the de-phasing based on the PFG at any position z.

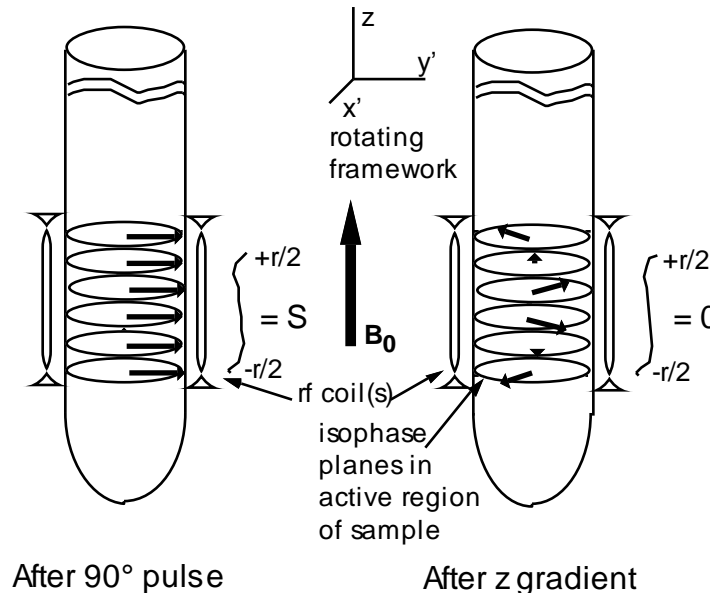

Pulsed Field Gradients

If we have a coherence order $p=+1$, then the phase acquired by this coherence under the PFG is:

$$I_+ \xrightarrow{\Omega(z)tI_z} \exp(-i\Omega(z)t)I_+$$

*The accumulated phase depends on the position of the spins.
If we have a coherence $p=+2$ then,*

$$I_{1+}I_{2+} \xrightarrow{\Omega(z)t(I_{1z}+I_{2z})} \exp(-i2\Omega(z)t)I_{1+}I_{2+}$$

$$I_+S_+ \xrightarrow{\Omega_I(z)tI_z + \Omega_S(z)tS_z} \exp(-i(\Omega_I(z) + \Omega_S(z))t)I_{1+}S_{2+}$$

Thus again we have the spatially dependent phase change due to PFG is proportional to the gradient strength G , duration t , γ , and coherence order p .

$$\phi(z) = -p\gamma Gzt$$

Coherence Pathway Selection with PFG

If we desire to select a coherence order $p=+2$, transferred to $p=-1$ pathway and then the pulse scheme may be designed as follows:

$$\phi_1(z) = -p_1 \gamma G_1 z \tau_1$$

$$\phi_2(z) = -p_2 \gamma G_2 z \tau_1$$

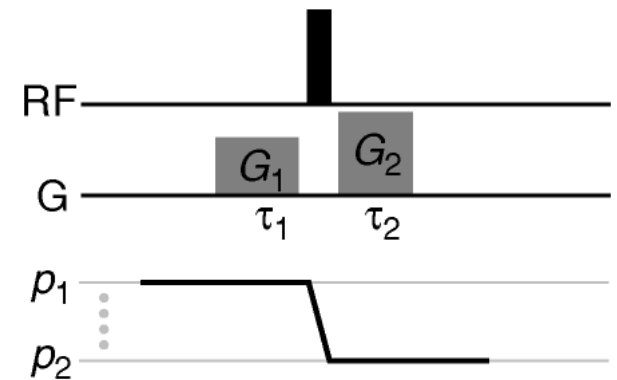

At the end of $\tau_1 + \tau_2$ period the total phase is $\phi_1 + \phi_2$. The selection or refocusing condition for this pathway is

$$\phi_1(z) + \phi_2(z) = -p_1 \gamma G_1 z \tau_1 - p_2 \gamma G_2 z \tau_1 = 0$$

$$\frac{G_1 \tau_1}{G_2 \tau_1} = -\frac{p_2}{p_1} = -\frac{-1}{2} = \frac{1}{2}$$

If we set $\tau_1 = \tau_2$ then $G_2 = 2G_1$.

Coherence Pathway Selection with PFG

In hetero nuclear systems, to select a coherence pathway we will have to consider the γ 's also

$$\phi_1(z) = -p_I \gamma_I G_1 z \tau_1 - p_S \gamma_S G_1 z \tau_1$$

$$\phi_2(z) = -p_I \gamma_I G_2 z \tau_2 - p_S \gamma_S G_2 z \tau_2$$

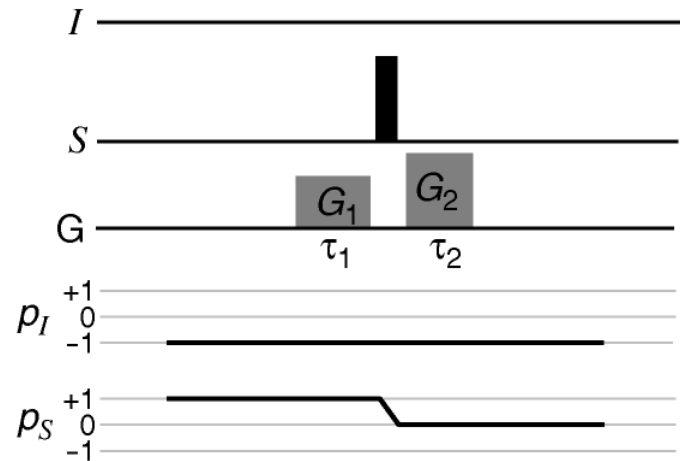

At the end of $\tau_1 + \tau_2$ period the total phase is $\phi_1 + \phi_2$. The selection or refocusing condition for this pathway is

$$\phi_1(z) = -(-1 \times \gamma_I + 1 \times \gamma_S) G_1 z \tau_1; \quad \phi_2(z) = -(-1 \times \gamma_I + 0 \times \gamma_S) G_2 z \tau_2$$

$$\phi_1(z) + \phi_2(z) = 0; \quad (\gamma_I - \gamma_S) G_1 z \tau_1 + \gamma_I G_2 z \tau_2 = 0$$

$$\frac{G_1 \tau_1}{G_2 \tau_2} = \frac{\gamma_I}{-(\gamma_I - \gamma_S)}$$

Spin Echo with PFG

Suppose, we insert two gradients of equal strength on either side of the π pulse in a spin-echo module, we still get an echo.

$$\phi_1(z) = -p\gamma Gz\tau$$

$$\phi_2(z) = -(-p)\gamma Gz\tau$$

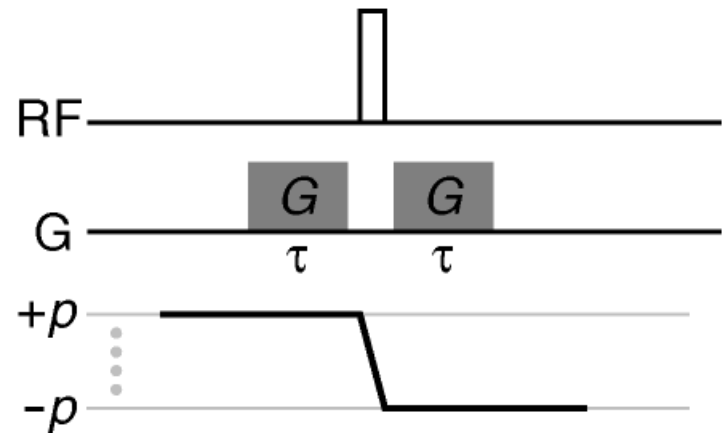

The π pulse converts $+p$ coherence into $-p$ coherence. At the end of 2τ period the total phase is $\phi_1=0$. Thus the π pulse refocuses the phase accumulations caused by the PFGs also.

DQFC with PFG

We can revisit the DQFC experiment, now we select the coherence transfer pathway with PFG. If we just set the second gradient twice as strong as the first the desired coherence transfer pathway is selected in just one scan. However the pathway through $p=-2$ is not selected. Thus **with PFG we will lose $\frac{1}{2}$ of the signal** (figure on the left) compared to phase cycled experiments. The variants of DQFC is shown.

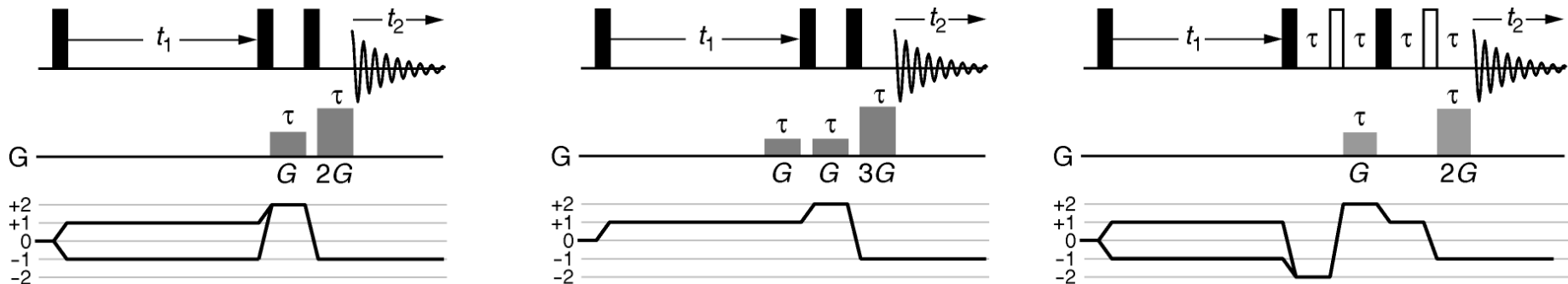

Spectrometer

A spectrometer is a complex equipment. There are several units that work together.

- A magnet that produces a homogeneous, intense, magnetic field*
- A field frequency lock and shim control unit*
- A probe in which the coils used to excite and detect the NMR signal and that generates pulsed field gradients are held close to the sample*
- RF transmitters to deliver short high-power pulses and long low power pulses.*
- Pulsed Field Gradient amplifiers that produce precise current for PFG generation*
- A sensitive RF receiver to detect and amplify NMR signals*
- A digital signal processing unit to convert NMR signal for processing*
- A pulse programmer to produce precisely timed pulses and delays*
- A pneumatics control that allow sample transport and sample temperature control*
- A computer to control all these equipments.*

Magnet, Lock, Shim

Magnet

Modern spectrometers use super conducting magnets that produces field along the vertical axis of the cylindrical Dewar. The field is usually referred by the proton resonance frequency. Commercially available magnets go up to 1 GHz in strength.

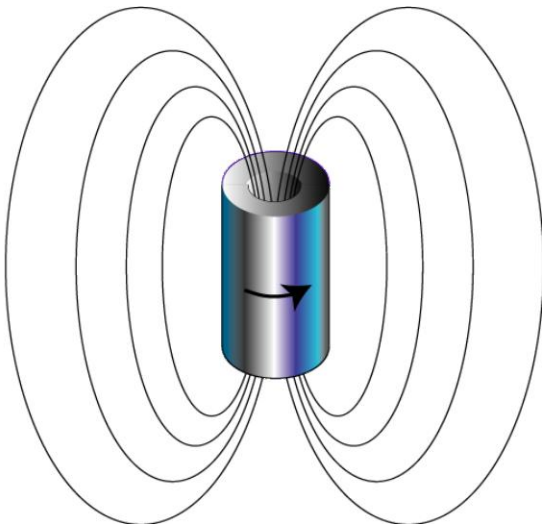

Magnet, Lock, Shim

Lock

Although the magnetic field produced by superconducting magnet is very stable, it drifts during the course of a NMR experiment. If uncorrected this drift will cause NMR lines to move in its position and distort the NMR spectrum. Field – frequency lock is a feedback system designed to keep the field at a steady value.

The lock uses ^2H signal from a deuterated solvent. Initially the lock signal is adjusted such that the lock receiver monitors the center of the dispersive component. The voltage at this point is zero. When the field drifts, the detector senses a voltage and the amount of frequency shift and a feedback current is generated to restore the center of the dispersion. The proportional response corrects fast changes and the integrating response corrects long term drift.

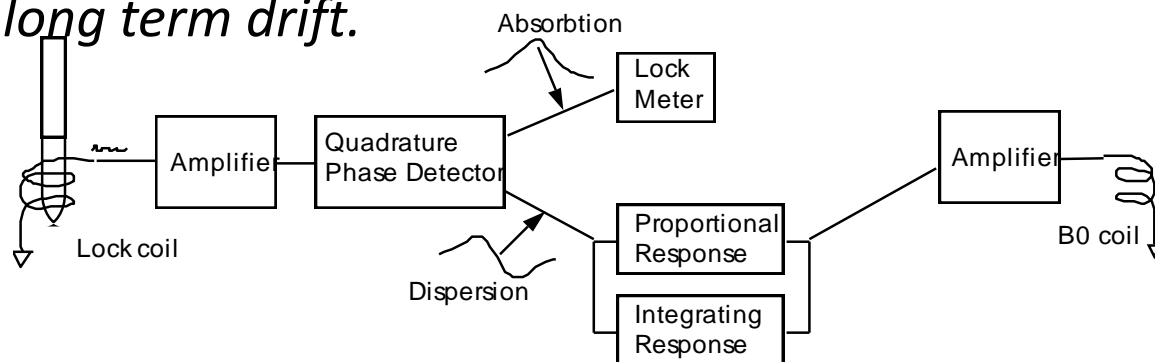

Magnet, Lock, Shim

Shims

*NMR linewidths of 1 Hz or less are common. So the magnetic field should not only be stable but also uniform or homogeneous over the sample. At 500 MHz the field is 11.75 T. If we want a homogeneous field that produces a line width of 0.1 Hz, then the change in the magnetic field should be less than $(0.1 * 2\pi) / \gamma = 2.4 \times 10^{-9}$ T.*

There are two types of shim coils (a) super conducting shims that surround the main coil with fixed amount of currents set at the time of magnet installation and (b) a room temperature setup of shim coils that surrounds the sample and the current through which can be adjusted by the experimenter to obtain a homogeneous field.

Shims are labeled according to the field profile they generate x, y, z, z²,...etc.

Probe

Probe

*The probe is a tube that is inserted into the magnet in which there is a coil to transmit RF and receive the FID. The coil is connected to two capacitors one is called **tune** and another called **match**. Adjusting the tune capacitor brings the circuit in resonance to the desired nucleus and adjusting the match brings the circuit impedance for maximum energy transfer.*

Tuning and matching the probe is similar to selecting a particular radio station in a radio.

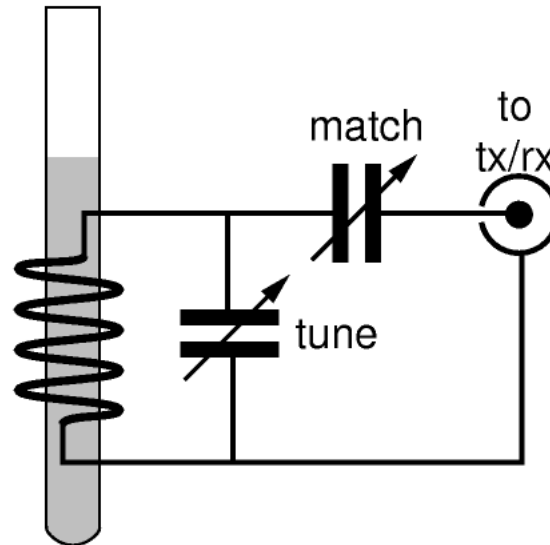

Transmitter

Transmitter

The transmitter contains a frequency synthesizer and an amplifier. The output of the synthesizer is gated to produce pulses. Also there are electronics that control the amplitude and phase of the RF pulses and passes through a power amplifier.

*The power P of the RF is set by the attenuator and is expressed in **decibell** units (dB units).*

$$p(\text{dB}) = 10 \log_{10} \frac{P_{\text{out}}}{P_{\text{in}}}$$

If $P_{\text{out}} = 2P_{\text{in}}$, then

$$p(\text{dB}) = 10 \log_{10} \frac{2}{1} = 10 \times 0.301 = 3.0$$

*For every 3dB change in attenuator setting the power changes by a factor of 2. **For 6dB change the power changes by a factor of 4 and the amplitude by a factor of 2.***

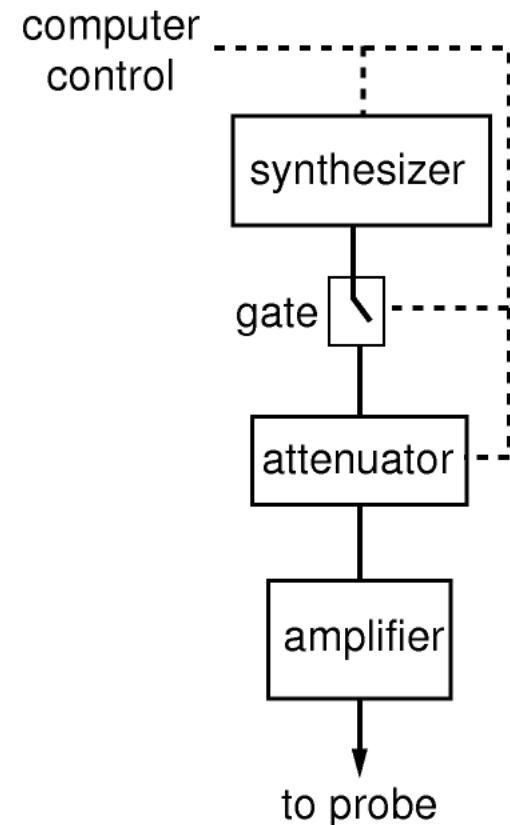

Receiver

Receiver

*The detected NMR signal is of very low strength, usually in μV levels. This signal gets amplified by a **preamplifier** and then digitized by a device called analog to digital converter (ADC). The ADC samples the signal at regular intervals resulting in the FID given as data points. ADC represents the FID in binary numbers. The largest number that can be represented depends on the number of bits of the ADC. For example if the ADC is 3 bit resolution then we can have – 000,001,010,011,100,101,110, and 111 ($8=2^3$ values). When the largest signal level exceeds the maximum digitizer value of ADC one gets ADC overflow.*

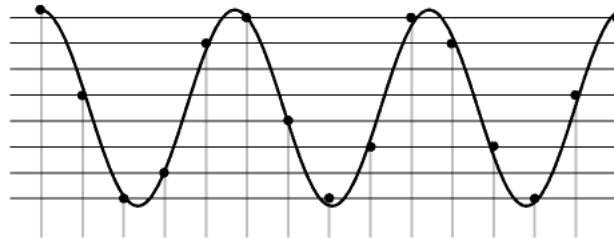

Receiver

Sampling

The FID is sampled at a rate depending on the spectral window that is observed. The sampling rate and the maximum frequency sampled are related by the expression below:

$$\Delta = \frac{1}{2f_{\max}}$$

With this sampling rate frequencies in the range $-f_{\max}$ to $+f_{\max}$ are represented correctly. This expression is also called Nyquist theorem and any signal outside this frequency range (a) will be folded (b).

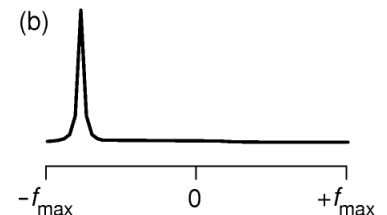
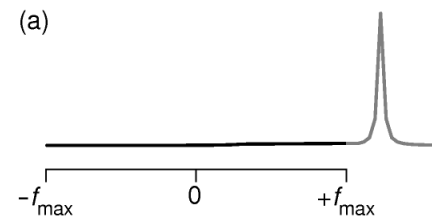
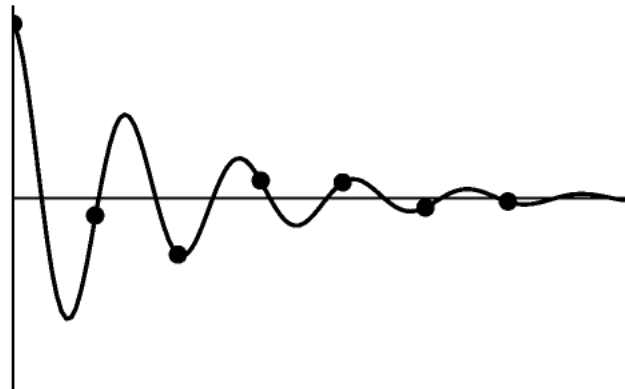
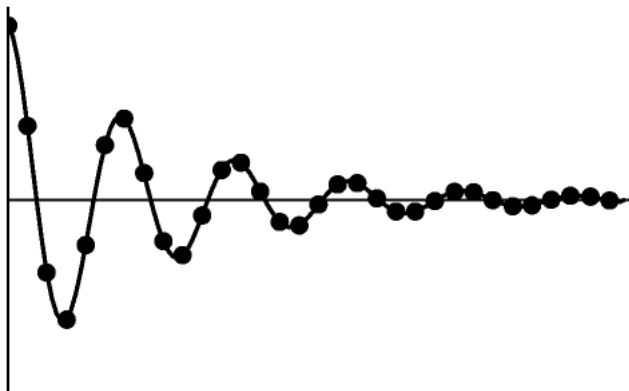

Receiver

Quadrature Detection

We represented FID as a complex signal $S(t)$ in our discussions of FT.

$$S(t) = S_x + iS_y$$

Such a signal is generated by a device called quadrature detector that is schematically represented below:

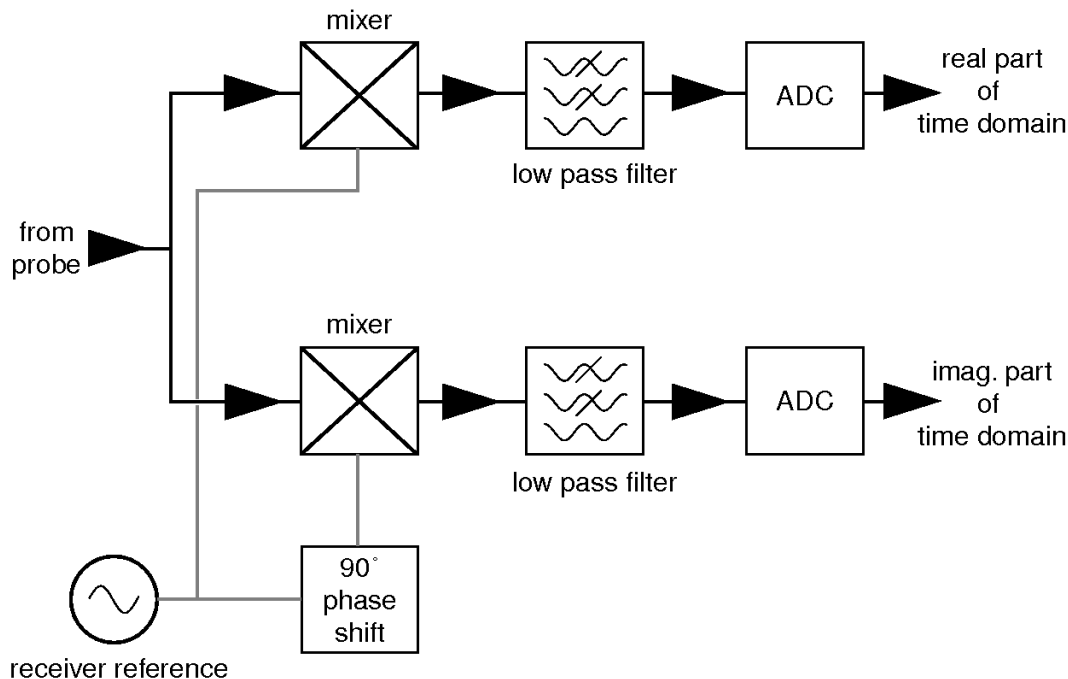

Pulse Programmer

The pulse programmer is a dedicated computer in the hardware that controls precise timing of all events in an experiment that is also programmable by the user. We say we write a pulse sequence program that is interpreted by this hardware which then sends out control signals to the individual components.